

# Data sheet | Item number: 765-1103/100-000

16-channel digital output; Profinet; DC 24 V / 2.0 A; 8xM12 connection;  
WideLine

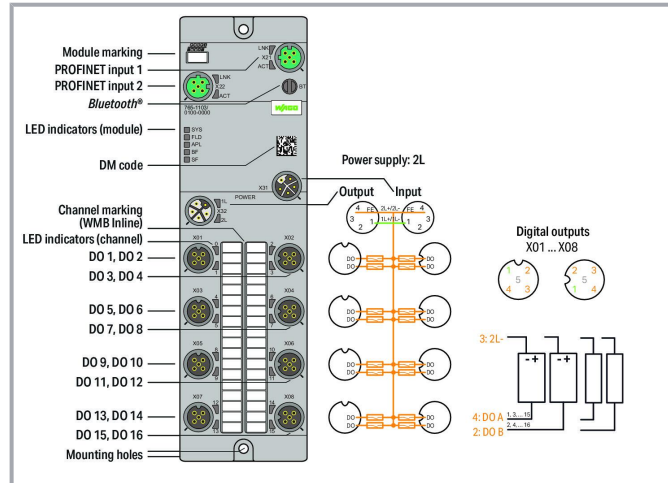

[www.wago.com/765-1103/100-000](http://www.wago.com/765-1103/100-000)



## Data

### Technical data

### Fieldbus

Communication

PROFINET  
PROFINET IO Device; 2-port switch, LLDP, MRP, SNMP  
PROFINET  
PROFINET IO Device; 2-port switch, LLDP, MRP, SNMP

Connection technology: communication/fieldbus	2 x D-coded M12; 4-pole
Interface standard	10BASE-T/100BASE-TX; potential-free
Autonegotiation; autocrossover	yes
PROFINET IO properties	PROFINET IO device; 2-port switch, LLDP, MRP, SNMP

### Device Functions

Parameters

Output current  
Temperature

Subject to changes. Please also observe the further product documentation!

WAGO GmbH & Co. KG  
Hansastr. 27  
32423 Minden  
Phone: +49571 887-0 | Fax: +49571 887-169  
Email: [info.de@wago.com](mailto:info.de@wago.com) | Web: [www.wago.com](http://www.wago.com)

Do you have any questions about our products?  
We are always happy to take your call at +49 (571) 887-44222.



Diagnostics	Undervoltage; Overcurrent; Overload; Overtemperature
Device functions	Bluetooth® Bluetooth® OPC UA Server
Visualization	Android/iOS app Webserver

### Digital inputs/outputs

Number of digital outputs	16
Connection technology: inputs/outputs	8 x A-coded M12; 5-pole
Voltage signal type	24 VDC
Output current (per channel)	2 A (typ.) for DO
Supply current per port	2L: 4 A (max.)

### Module Power Supply

Connection technology: supply	2 x L-coded M12; 5-pole
Supply voltage	24 VDC (18 ... 31.2 V); 1L/2L
Power consumption (max.)	16000 mA
Power consumption (note)	per supply line; overload- and short-circuit-protected
Reverse voltage protection	Yes

### Geometrical Data

Width	60 mm / 2.362 inch
Height	30 mm / 1.181 inch
Depth	210 mm / 8.268 inch

### Mechanical Data

Weight	610 g
Conformity marking	CE

### Environmental Requirements

Surrounding air temperature (operation)	-25 ... +70 °C
Surrounding air temperature (storage)	-40 ... +80 °C
Protection type	IP67
Protection class	III per EN 61140, IEC 61140, VDE 0140-1
Operating altitude	0 ... 2000 m
Pollution degree (5)	3 per EN 60664-1

Subject to changes. Please also observe the further product documentation!

WAGO GmbH & Co. KG  
 Hansastr. 27  
 32423 Minden  
 Phone: +49571 887-0 | Fax: +49571 887-169  
 Email: [info.de@wago.com](mailto:info.de@wago.com) | Web: [www.wago.com](http://www.wago.com)

Do you have any questions about our products?  
 We are always happy to take your call at +49 (571) 887-44222.

Overvoltage category	II (EN 60664-1)
Relative humidity (without condensation)	95 %
Vibration resistance	5g per IEC 60068-2-6
Shock resistance	Short-term: 50g/11 ms/half-sine per IEC 60068-2-27; Long-term: 30g/6 ms/half-sine per IEC 60068-2-29
EMC immunity to interference	per EN 61000-6-2
EMC emission of interference	per EN 61000-6-4

## Commercial data



PU (SPU)	1 Stück
Packaging type	box
Country of origin	DE
GTIN	4055143949972
Customs tariff number	85371098990

## Required accessories

### Cover

Cover		
	<b>Item no.: 756-8102</b> M12 protective cap; for unused sockets	<a href="http://www.wago.com/756-8102">www.wago.com/756-8102</a>
	<b>Item no.: 756-8103</b> M12 protective cap; for unused plugs	<a href="http://www.wago.com/756-8103">www.wago.com/756-8103</a>

### Marking accessories

Marking strip		
	<b>Item no.: 2009-110</b> Marking strips; for Smart Printer; on reel; not stretchable; plain; snap-on type; white	<a href="http://www.wago.com/2009-110">www.wago.com/2009-110</a>
Marker		
	<b>Item no.: 2009-115</b> WMB-Inline; for Smart Printer; 1500 pieces on roll; stretchable 5 - 5.2 mm; plain; snap-on type; white	<a href="http://www.wago.com/2009-115">www.wago.com/2009-115</a>

### Tool

Assembly tool		
	<b>Item no.: 206-701</b> Torque wrench M8 and M12; Assembly kit	<a href="http://www.wago.com/206-701">www.wago.com/206-701</a>

## Optional accessories

### Cables and pluggable connectors

Sensor/actuator cable		
-----------------------	--	--

Subject to changes. Please also observe the further product documentation!



**Item no.: 756-5402/040-010**

Sensor/Actuator cable; M12A socket; straight; M12A plug; angled; 4-pole; Length: 1 m

[www.wago.com/756-5402/040-010](http://www.wago.com/756-5402/040-010)

**Item no.: 756-5402/040-020**

Sensor/Actuator cable; M12A socket; straight; M12A plug; angled; 4-pole; Length: 2 m

[www.wago.com/756-5402/040-020](http://www.wago.com/756-5402/040-020)

**Item no.: 756-5311/040-050**

Sensor/Actuator cable; M12A plug; straight; 4-pole; Length: 5 m

[www.wago.com/756-5311/040-050](http://www.wago.com/756-5311/040-050)

**Item no.: 756-5311/040-015**

Sensor/Actuator cable; M12A plug; straight; 4-pole; Length: 1.5 m

[www.wago.com/756-5311/040-015](http://www.wago.com/756-5311/040-015)

**Item no.: 756-5311/040-100**

Sensor/Actuator cable; M12A plug; straight; 4-pole; Length: 10 m

[www.wago.com/756-5311/040-100](http://www.wago.com/756-5311/040-100)

**Item no.: 756-5404/040-020**

Sensor/Actuator cable; M12A socket; angled; M12A plug; angled; 4-pole; Length: 2 m

[www.wago.com/756-5404/040-020](http://www.wago.com/756-5404/040-020)

**Item no.: 756-5510/040-010**

Sensor/Actuator cable; M8 socket; angled; M12A plug; angled; 4-pole; Length: 1 m

[www.wago.com/756-5510/040-010](http://www.wago.com/756-5510/040-010)

**Item no.: 756-5510/040-020**

Sensor/Actuator cable; M8 socket; angled; M12A plug; angled; 4-pole; Length: 2 m

[www.wago.com/756-5510/040-020](http://www.wago.com/756-5510/040-020)

**Item no.: 756-5401/040-020**

Sensor/Actuator cable; M12A socket; straight; M12A plug; straight; 4-pole; Length: 2 m

[www.wago.com/756-5401/040-020](http://www.wago.com/756-5401/040-020)

**Item no.: 756-5401/040-010**

Sensor/Actuator cable; M12A socket; straight; M12A plug; straight; 4-pole; Length: 1 m

[www.wago.com/756-5401/040-010](http://www.wago.com/756-5401/040-010)

**Item no.: 756-5507/040-010**

Sensor/Actuator cable; M8 socket; straight; M12A plug; straight; 4-pole; Length: 1 m

[www.wago.com/756-5507/040-010](http://www.wago.com/756-5507/040-010)

**Item no.: 756-5507/040-020**

Sensor/Actuator cable; M8 socket; straight; M12A plug; straight; 4-pole; Length: 2 m

[www.wago.com/756-5507/040-020](http://www.wago.com/756-5507/040-020)

**Item no.: 756-5404/040-010**

Sensor/Actuator cable; M12A socket; angled; M12A plug; angled; 4-pole; Length: 1 m

[www.wago.com/756-5404/040-010](http://www.wago.com/756-5404/040-010)

Subject to changes. Please also observe the further product documentation!

WAGO GmbH & Co. KG

Hansastr. 27

32423 Minden

Phone: +49571 887-0 | Fax: +49571 887-169

Email: [info.de@wago.com](mailto:info.de@wago.com) | Web: [www.wago.com](http://www.wago.com)

Do you have any questions about our products?

We are always happy to take your call at +49 (571) 887-44222.

**Item no.: 756-5312/040-015**  
Sensor/Actuator cable; M12B socket; straight; 4-pole; Length: 1.5 m

[www.wago.com/756-5312/040-015](http://www.wago.com/756-5312/040-015)

**Item no.: 756-5312/040-050**  
Sensor/Actuator cable; M12B socket; straight; 4-pole; Length: 5 m

[www.wago.com/756-5312/040-050](http://www.wago.com/756-5312/040-050)

**Item no.: 756-5509/040-010**  
Sensor/Actuator cable; M8 socket; angled; M12A plug; straight; 4-pole; Length: 1 m

[www.wago.com/756-5509/040-010](http://www.wago.com/756-5509/040-010)

**Item no.: 756-5509/040-020**  
Sensor/Actuator cable; M8 socket; angled; M12A plug; straight; 4-pole; Length: 2 m

[www.wago.com/756-5509/040-020](http://www.wago.com/756-5509/040-020)

**Item no.: 756-5403/040-010**  
Sensor/Actuator cable; M12A socket; angled; M12A plug; straight; 4-pole; Length: 1 m

[www.wago.com/756-5403/040-010](http://www.wago.com/756-5403/040-010)

**Item no.: 756-5312/040-100**  
Sensor/Actuator cable; M12B socket; straight; 4-pole; Length: 10 m

[www.wago.com/756-5312/040-100](http://www.wago.com/756-5312/040-100)

**Item no.: 756-5403/040-020**  
Sensor/Actuator cable; M12A socket; angled; M12A plug; straight; 4-pole; Length: 2 m

[www.wago.com/756-5403/040-020](http://www.wago.com/756-5403/040-020)



**Item no.: 756-5508/040-010**  
Sensor/Actuator cable; M8 socket; straight; M12A plug; angled; 4-pole; Length: 1 m

[www.wago.com/756-5508/040-010](http://www.wago.com/756-5508/040-010)



**Item no.: 756-5508/040-020**  
Sensor/Actuator cable; M8 socket; straight; M12A plug; angled; 4-pole; Length: 2 m

[www.wago.com/756-5508/040-020](http://www.wago.com/756-5508/040-020)

#### Configurable connectors

**Item no.: 756-9202/040-000**  
Fitted pluggable connector; 4-pole; M12 plug, straight, A-coded; Spring

[www.wago.com/756-9202/040-000](http://www.wago.com/756-9202/040-000)

**Item no.: 756-9205/040-000**  
Fitted pluggable connector; 4-pole; M12 plug, right angle; Spring

[www.wago.com/756-9205/040-000](http://www.wago.com/756-9205/040-000)



**Item no.: 756-9711/050-000**  
Fitted pluggable connector; 5-pole, shielded; M12 socket, straight; IDC technology

[www.wago.com/756-9711/050-000](http://www.wago.com/756-9711/050-000)



**Item no.: 756-9701/050-000**  
Fitted pluggable connector; 5-pole, shielded; M12 plug, straight; IDC technology

[www.wago.com/756-9701/050-000](http://www.wago.com/756-9701/050-000)

Subject to changes. Please also observe the further product documentation!

Configurable shielded connectors

**Item no.: 756-9501/060-000**

Fitted pluggable connector; 5-pole, shielded; M12 plug, straight, D-coded; Spring

[www.wago.com/756-9501/060-000](http://www.wago.com/756-9501/060-000)

**Item no.: 756-9501/040-000**

Accessories; M12 plug, right angle; 4-pole

[www.wago.com/756-9501/040-000](http://www.wago.com/756-9501/040-000)

Power cable



**Item no.: 756-3501/050-075**

Power cable; M12L socket; straight; 5-pole; Length: 7.5 m

[www.wago.com/756-3501/050-075](http://www.wago.com/756-3501/050-075)



**Item no.: 756-3501/050-100**

Power cable; M12L socket; straight; 5-pole; Length: 10 m

[www.wago.com/756-3501/050-100](http://www.wago.com/756-3501/050-100)



**Item no.: 756-3501/050-150**

Power cable; M12L socket; straight; 5-pole; Length: 15 m

[www.wago.com/756-3501/050-150](http://www.wago.com/756-3501/050-150)



**Item no.: 756-3501/050-050**

Power cable; M12L socket; straight; 5-pole; Length: 5 m

[www.wago.com/756-3501/050-050](http://www.wago.com/756-3501/050-050)



**Item no.: 756-3502/050-050**

Power cable; M12L socket; angled; 5-pole; Length: 5 m

[www.wago.com/756-3502/050-050](http://www.wago.com/756-3502/050-050)



**Item no.: 756-3502/050-150**

Power cable; M12L socket; angled; 5-pole; Length: 15 m

[www.wago.com/756-3502/050-150](http://www.wago.com/756-3502/050-150)



**Item no.: 756-3502/050-075**

Power cable; M12L socket; angled; 5-pole; Length: 7.5 m

[www.wago.com/756-3502/050-075](http://www.wago.com/756-3502/050-075)



**Item no.: 756-3502/050-100**

Power cable; M12L socket; angled; 5-pole; Length: 10 m

[www.wago.com/756-3502/050-100](http://www.wago.com/756-3502/050-100)

Subject to changes. Please also observe the further product documentation!

WAGO GmbH & Co. KG

Hansastr. 27













32423 Minden

Phone: +49571 887-0 | Fax: +49571 887-169













Email: [info.de@wago.com](mailto:info.de@wago.com) | Web: [www.wago.com](http://www.wago.com)

Do you have any questions about our products?

We are always happy to take your call at +49 (571) 887-44222.

	<b>Item no.: 756-3503/050-075</b> Power cable; M12L plug; straight; 5-pole; Length: 7.5 m	<a href="http://www.wago.com/756-3503/050-075">www.wago.com/756-3503/050-075</a>
	<b>Item no.: 756-3503/050-150</b> Power cable; M12L plug; straight; 5-pole; Length: 15 m	<a href="http://www.wago.com/756-3503/050-150">www.wago.com/756-3503/050-150</a>
	<b>Item no.: 756-3503/050-100</b> Power cable; M12L plug; straight; 5-pole; Length: 10 m	<a href="http://www.wago.com/756-3503/050-100">www.wago.com/756-3503/050-100</a>
	<b>Item no.: 756-3505/050-003</b> Power cable; M12L socket; straight; M12L plug; straight; 5-pole; Length: 0.3 m	<a href="http://www.wago.com/756-3505/050-003">www.wago.com/756-3505/050-003</a>
	<b>Item no.: 756-3505/050-005</b> Power cable; M12L socket; straight; M12L plug; straight; 5-pole; Length: 0.5 m	<a href="http://www.wago.com/756-3505/050-005">www.wago.com/756-3505/050-005</a>
	<b>Item no.: 756-3505/050-020</b> Power cable; M12L socket; straight; M12L plug; straight; 5-pole; Length: 2 m	<a href="http://www.wago.com/756-3505/050-020">www.wago.com/756-3505/050-020</a>
	<b>Item no.: 756-3505/050-010</b> Power cable; M12L socket; straight; M12L plug; straight; 5-pole; Length: 1 m	<a href="http://www.wago.com/756-3505/050-010">www.wago.com/756-3505/050-010</a>
	<b>Item no.: 756-3505/050-050</b> Power cable; M12L socket; straight; M12L plug; straight; 5-pole; Length: 5 m	<a href="http://www.wago.com/756-3505/050-050">www.wago.com/756-3505/050-050</a>
	<b>Item no.: 756-3505/050-075</b> Power cable; M12L socket; straight; M12L plug; straight; 5-pole; Length: 7.5 m	<a href="http://www.wago.com/756-3505/050-075">www.wago.com/756-3505/050-075</a>
	<b>Item no.: 756-3505/050-100</b> Power cable; M12L socket; straight; M12L plug; straight; 5-pole; Length: 10 m	<a href="http://www.wago.com/756-3505/050-100">www.wago.com/756-3505/050-100</a>
	<b>Item no.: 756-3506/050-100</b> Power cable; M12L socket; angled; M12L plug; angled; 5-pole; Length: 10 m	<a href="http://www.wago.com/756-3506/050-100">www.wago.com/756-3506/050-100</a>
	<b>Item no.: 756-3506/050-075</b> Power cable; M12L socket; angled; M12L plug; angled; 5-pole; Length: 7.5 m	<a href="http://www.wago.com/756-3506/050-075">www.wago.com/756-3506/050-075</a>
	<b>Item no.: 756-3506/050-150</b> Power cable; M12L socket; angled; M12L plug; angled; 5-pole; Length: 15 m	<a href="http://www.wago.com/756-3506/050-150">www.wago.com/756-3506/050-150</a>

Subject to changes. Please also observe the further product documentation!

	<b>Item no.: 756-3501/050-020</b> Power cable; M12L socket; straight; 5-pole; Length: 2 m	<a href="http://www.wago.com/756-3501/050-020">www.wago.com/756-3501/050-020</a>
	<b>Item no.: 756-3502/050-020</b> Power cable; M12L socket; angled; 5-pole; Length: 2 m	<a href="http://www.wago.com/756-3502/050-020">www.wago.com/756-3502/050-020</a>
	<b>Item no.: 756-3503/050-020</b> Power cable; M12L plug; straight; 5-pole; Length: 2 m	<a href="http://www.wago.com/756-3503/050-020">www.wago.com/756-3503/050-020</a>
	<b>Item no.: 756-3503/050-050</b> Power cable; M12L plug; straight; 5-pole; Length: 5 m	<a href="http://www.wago.com/756-3503/050-050">www.wago.com/756-3503/050-050</a>
	<b>Item no.: 756-3504/050-020</b> Power cable; M12L plug; angled; 5-pole; Length: 2 m	<a href="http://www.wago.com/756-3504/050-020">www.wago.com/756-3504/050-020</a>
	<b>Item no.: 756-3504/050-050</b> Power cable; M12L plug; angled; 5-pole; Length: 5 m	<a href="http://www.wago.com/756-3504/050-050">www.wago.com/756-3504/050-050</a>
	<b>Item no.: 756-3504/050-075</b> Power cable; M12L plug; angled; 5-pole; Length: 7.5 m	<a href="http://www.wago.com/756-3504/050-075">www.wago.com/756-3504/050-075</a>
	<b>Item no.: 756-3504/050-100</b> Power cable; M12L plug; angled; 5-pole; Length: 10 m	<a href="http://www.wago.com/756-3504/050-100">www.wago.com/756-3504/050-100</a>
	<b>Item no.: 756-3504/050-150</b> Power cable; M12L plug; angled; 5-pole; Length: 15 m	<a href="http://www.wago.com/756-3504/050-150">www.wago.com/756-3504/050-150</a>
	<b>Item no.: 756-3505/050-150</b> Power cable; M12L socket; straight; M12L plug; straight; 5-pole; Length: 15 m	<a href="http://www.wago.com/756-3505/050-150">www.wago.com/756-3505/050-150</a>
	<b>Item no.: 756-3506/050-003</b> Power cable; M12L socket; angled; M12L plug; angled; 5-pole; Length: 0.3 m	<a href="http://www.wago.com/756-3506/050-003">www.wago.com/756-3506/050-003</a>
	<b>Item no.: 756-3506/050-005</b> Power cable; M12L socket; angled; M12L plug; angled; 5-pole; Length: 0.5 m	<a href="http://www.wago.com/756-3506/050-005">www.wago.com/756-3506/050-005</a>

Subject to changes. Please also observe the further product documentation!





**Item no.: 756-3506/050-020**  
Power cable; M12L socket; angled; M12L plug; angled; 5-pole; Length: 2 m

[www.wago.com/756-3506/050-020](http://www.wago.com/756-3506/050-020)



**Item no.: 756-3506/050-010**  
Power cable; M12L socket; angled; M12L plug; angled; 5-pole; Length: 1 m

[www.wago.com/756-3506/050-010](http://www.wago.com/756-3506/050-010)



**Item no.: 756-3506/050-050**  
Power cable; M12L socket; angled; M12L plug; angled; 5-pole; Length: 5 m

[www.wago.com/756-3506/050-050](http://www.wago.com/756-3506/050-050)

Distribution connector

**Item no.: 756-5513/040-010**  
Sensor/Actuator cable; 2xM8 socket; straight; M12A plug; straight; 4-pole; Length: 1 m

[www.wago.com/756-5513/040-010](http://www.wago.com/756-5513/040-010)

**Item no.: 756-5513/040-020**  
Sensor/Actuator cable; 2xM8 socket; straight; M12A plug; straight; 4-pole; Length: 2 m

[www.wago.com/756-5513/040-020](http://www.wago.com/756-5513/040-020)

**Item no.: 756-5514/040-010**  
Sensor/Actuator cable; 2xM8 socket; angled; M12A plug; straight; 4-pole; Length: 1 m

[www.wago.com/756-5514/040-010](http://www.wago.com/756-5514/040-010)

**Item no.: 756-5514/040-020**  
Sensor/Actuator cable; 2xM8 socket; angled; M12A plug; straight; 4-pole; Length: 2 m

[www.wago.com/756-5514/040-020](http://www.wago.com/756-5514/040-020)

**Item no.: 756-5516/040-010**  
Sensor/Actuator cable; 2xM12 socket; straight; M12A plug; straight; 4-pole; Length: 1 m

[www.wago.com/756-5516/040-010](http://www.wago.com/756-5516/040-010)

**Item no.: 756-5516/040-020**  
Sensor/Actuator cable; 2xM12 socket; straight; M12A plug; straight; 4-pole; Length: 2 m

[www.wago.com/756-5516/040-020](http://www.wago.com/756-5516/040-020)

**Item no.: 756-5517/040-010**  
Sensor/Actuator cable; 2xM12 socket; angled; M12A plug; straight; 4-pole; Length: 1 m

[www.wago.com/756-5517/040-010](http://www.wago.com/756-5517/040-010)

**Item no.: 756-5517/040-020**  
Sensor/Actuator cable; 2xM12 socket; angled; M12A plug; straight; 4-pole; Length: 2 m

[www.wago.com/756-5517/040-020](http://www.wago.com/756-5517/040-020)



**Item no.: 756-9301/050-000**  
Accessories; 5-pole

[www.wago.com/756-9301/050-000](http://www.wago.com/756-9301/050-000)

**Item no.: 756-9301/040-000**  
Accessories; 4-pole

[www.wago.com/756-9301/040-000](http://www.wago.com/756-9301/040-000)

Subject to changes. Please also observe the further product documentation!

Adapter



**Item no.:** 756-9503/040-000  
Accessories; 4-pole

[www.wago.com/756-9503/040-000](http://www.wago.com/756-9503/040-000)

**Item no.:** 756-9504/040-000  
Accessories; 4-pole

[www.wago.com/756-9504/040-000](http://www.wago.com/756-9504/040-000)

ETHERNET/PROFINET cable



**Item no.:** 756-1202/060-200  
ETHERNET cable; M12D plug; angled; 4-pole; Length: 20 m

[www.wago.com/756-1202/060-200](http://www.wago.com/756-1202/060-200)



**Item no.:** 756-1201/060-100  
ETHERNET cable; M12D plug; straight; 4-pole; Length: 10 m

[www.wago.com/756-1201/060-100](http://www.wago.com/756-1201/060-100)



**Item no.:** 756-1201/060-050  
ETHERNET cable; M12D plug; straight; 4-pole; Length: 5 m

[www.wago.com/756-1201/060-050](http://www.wago.com/756-1201/060-050)



**Item no.:** 756-1203/060-050  
ETHERNET cable; M12D plug; straight; M12D plug; straight; 4-pole; Length: 5 m

[www.wago.com/756-1203/060-050](http://www.wago.com/756-1203/060-050)



**Item no.:** 756-1203/060-020  
ETHERNET cable; M12D plug; straight; M12D plug; straight; 4-pole; Length: 2 m

[www.wago.com/756-1203/060-020](http://www.wago.com/756-1203/060-020)



**Item no.:** 756-1202/060-020  
ETHERNET cable; M12D plug; angled; 4-pole; Length: 2 m

[www.wago.com/756-1202/060-020](http://www.wago.com/756-1202/060-020)



**Item no.:** 756-1201/060-200  
ETHERNET cable; M12D plug; straight; 4-pole; Length: 20 m

[www.wago.com/756-1201/060-200](http://www.wago.com/756-1201/060-200)



**Item no.:** 756-1204/060-050  
ETHERNET cable; M12D plug; angled; M12D plug; angled; 4-pole; Length: 5 m



[www.wago.com/756-1204/060-050](http://www.wago.com/756-1204/060-050)



**Item no.:** 756-1204/060-100  
ETHERNET cable; M12D plug; angled; M12D plug; angled; 4-pole; Length: 10 m

[www.wago.com/756-1204/060-100](http://www.wago.com/756-1204/060-100)

Subject to changes. Please also observe the further product documentation!

	<b>Item no.:</b> 756-1204/060-200 ETHERNET cable; M12D plug; angled; M12D plug; angled; 4-pole; Length: 20 m	<a href="http://www.wago.com/756-1204/060-200">www.wago.com/756-1204/060-200</a>
	<b>Item no.:</b> 756-1203/060-200 ETHERNET cable; M12D plug; straight; M12D plug; straight; 4-pole; Length: 20 m	<a href="http://www.wago.com/756-1203/060-200">www.wago.com/756-1203/060-200</a>
	<b>Item no.:</b> 756-1203/060-100 ETHERNET cable; M12D plug; straight; M12D plug; straight; 4-pole; Length: 10 m	<a href="http://www.wago.com/756-1203/060-100">www.wago.com/756-1203/060-100</a>
	<b>Item no.:</b> 756-1204/060-010 ETHERNET cable; M12D plug; angled; M12D plug; angled; 4-pole; Length: 0.1 m	<a href="http://www.wago.com/756-1204/060-010">www.wago.com/756-1204/060-010</a>
	<b>Item no.:</b> 756-1204/060-030 ETHERNET cable; M12D plug; angled; M12D plug; angled; 4-pole; Length: 3 m	<a href="http://www.wago.com/756-1204/060-030">www.wago.com/756-1204/060-030</a>
	<b>Item no.:</b> 756-1204/060-020 ETHERNET cable; M12D plug; angled; M12D plug; angled; 4-pole; Length: 2 m	<a href="http://www.wago.com/756-1204/060-020">www.wago.com/756-1204/060-020</a>
	<b>Item no.:</b> 756-1202/060-050 ETHERNET cable; M12D plug; angled; 4-pole; Length: 5 m	<a href="http://www.wago.com/756-1202/060-050">www.wago.com/756-1202/060-050</a>
	<b>Item no.:</b> 756-1202/060-100 ETHERNET cable; M12D plug; angled; 4-pole; Length: 10 m	<a href="http://www.wago.com/756-1202/060-100">www.wago.com/756-1202/060-100</a>
	<b>Item no.:</b> 756-1201/060-020 ETHERNET cable; M12D plug; straight; 4-pole; Length: 2 m	<a href="http://www.wago.com/756-1201/060-020">www.wago.com/756-1201/060-020</a>

## Downloads Documentation

### Manual

16-Channel Digital Output; Profinet DC 24 V / 2.0 A; 8xM12 Connection; WideLine	V 2.1.0 2020年11月30日	pdf 3.8 MB	Download
--	------------------------	---------------	----------

### System Description

WAGO I/O System Field; General Product Information	pdf 708.2 kB	Download
--	-----------------	----------

Subject to changes. Please also observe the further product documentation!



## Runtime Software

### Firmware

Profinet IO-Field 765-x1xx Firmware Download WAGO_FW0765-x1xx_V01010016_IX02.zip	V 02 2021年7月23日	zip 1.6 MB	Download
---	--------------------	---------------	----------

## CAD/CAE-Data

### CAD data

2D/3D Models 765-1103/100-000		URL	Download
-------------------------------	--	-----	----------

### CAE data

ZUKEN Portal 765-1103/100-000		URL	Download
-------------------------------	--	-----	----------

## Device Files

### Device Description File

750-916; GSD-Dateien der Version 2.x für PROFINET/ Serie 750/753, 765, 767 und 852	2.9 2021年10月15日	zip 2.5 MB	Download
Gerätebeschreibungsdateien 765-41xx, 765-11xx, PROFINET	V1_1_0_20	zip 27 B	Download

## Environmental Product Compliance

### Compliance Search

Environmental Product Compliance 765-1103/100-000 16-channel digital output; Profinet; DC 24 V / 2.0 A; 8xM12 connection; WideLine		URL	Download
---	--	-----	----------

## Installation Notes

Subject to changes. Please also observe the further product documentation!

WAGO GmbH & Co. KG  
Hansastr. 27  
32423 Minden  
Phone: +49571 887-0 | Fax: +49571 887-169  
Email: [info.de@wago.com](mailto:info.de@wago.com) | Web: [www.wago.com](http://www.wago.com)

Do you have any questions about our products?  
We are always happy to take your call at +49 (571) 887-44222.



## Product family

WAGO I/O System Field

[Show all products from the family](#)

Subject to changes. Please also observe the further product documentation!

---

WAGO GmbH & Co. KG

Hansastr. 27

32423 Minden

Phone: +49571 887-0 | Fax: +49571 887-169

Email: [info.de@wago.com](mailto:info.de@wago.com) | Web: [www.wago.com](http://www.wago.com)

Do you have any questions about our products?

We are always happy to take your call at +49 (571) 887-44222.